



Voyager[®] Pro

Analytical and Precision Balances



When your applications demand more than a standard balance, the OHAUS Voyager[®] Pro is up to the task.

Voyager[®] Pro's Advanced Applications simplify even the most complex laboratory measurements. Whether it's determining the difference between initial and residual weights or calculating the density of solids and liquids, Voyager Pro eliminates the need for time consuming manual calculations and data logging.

Standard Features Include:

- AutoCal™ automatic internal calibration system
- The most advanced application modes in the industry include: Statistics, Formulation, Differential Weighing, Statistical Quality Control (SQC), Density Determination and Pipette Calibration
- Standard application modes include: Percent Weighing, Animal Weighing, Check Weighing, Filling, Parts Counting and Gross/Net/Tare Weighing
- Applications library to store and quickly recall past procedures
- Brilliant backlit high resolution dot matrix display with simple navigation windows and menus to guide you through balance functions
- User selectable GLP/GMP outputs via RS232 to meet traceability requirements
- User selectable filter, stability indicator and auto-zero tracking for use in difficult environments
- Five operating languages—English, Spanish, French, German, Italian
- Weigh-below hook for below-balance weighing applications
- Protective in-use cover and security bracket
- Industry leading warranty and support

For absolute reliability and precision, simplicity in function and operation, exceptional value, and unsurpassed OHAUS support, Voyager Pro is the balance of choice

Voyager[®] Pro Electronic Balances

Voyager Pro Applications

Advanced in applications but not in operation. With Voyager Pro's dot matrix display and innovative user interface, balance setup and use is effortless. For superior weighing performance, Voyager Pro's AutoCal™ feature automatically calibrates the balance when it senses a temperature change sufficient enough to affect weighing accuracy.

For maximum accuracy, the Voyager Pro Series features 4 analytical models with capacities up to 210g with a 0.1mg readability. The draftshield design provides optimum draft protection from wind currents for superior balance stability and reproducibility even in challenging environments.

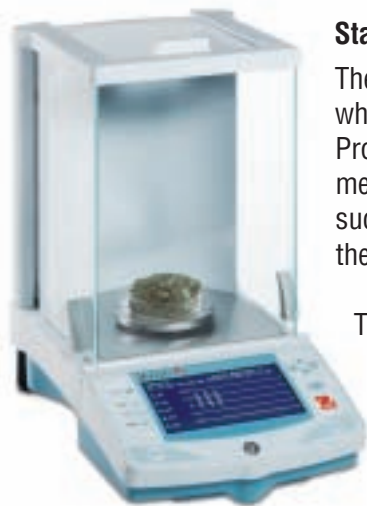

Statistical Quality Control (SQC)

The SQC feature is extremely useful during various types of process filling operations when it is desired to monitor and control the process to eliminate under and over filling. Provisions are made in the balance to accommodate the weight of various packaging methods. During operation, parameters of the packaged product are set into the balance such as packaging weight, acceptable weight limits and non-acceptable weight limits of the product.

These weight limits are identified as +T1, +T2, NOMINAL and -T1, -T2. As samples are weighed and stored in the balance, a trend analysis is developed and displayed on the balance. Up to 25 samples in a batch with up to ten batches are visible on a trend screen for quality control purposes. Each batch of samples is shown on the display which indicates the maximum/minimum standard deviation and mean values for each batch. An on going examination of the relative deviation of the samples along with other statistical data can be viewed and is stored. By observing the results of the *VIEW TRACE* screen, you can effectively monitor the filling process operation.

Statistics

```
Start Sample 11/17/03 01:26:24 PM
Total Batches 3
Total Samples 30
Mean 0.5575
Maximum 0.5664
Minimum 0.5463
Std. Deviation 0.0064
+T1 33.33 % 18
+T2 20.00 % 6
+T3 46.67 % 14
-T1 0.00 % 0
-T2 0.00 % 0
Last Sample 11/17/03 01:31:20 PM
```

Statistics are used when it is desired to compare a number of samples and examine the relative deviation of the samples along with other statistical data. A minimum of three samples

are required in this program. Statistics contains menu options which include: number of samples, maximum, minimum, difference, sum, mean, standard deviation, relative deviation, auto sample, and auto print. Weighing, Animal Weighing, Check Weighing and Filling application modes can also be linked to the Statistics mode to provide statistical data.

Differential Weighing

Differential weighing stores tare and weight values so samples can be dried or processed and the difference in weight be calculated. Up to 80 samples can be stored.

The balance has the capability to work with one or two different containers or no container at all.

Sample #	Init. Wt	Final Wt	Wt Diff
1	10.9965	9.9962	-0.9963
2	10.9961	9.9962	-0.9979
3	10.9961	9.9962	-0.9979
4	10.9962	9.9962	-0.9968
5	10.9964	9.9962	-0.9961
6	10.9962	9.9962	-0.9968
7	10.9964	9.9962	-0.9962
8	10.9963	9.9962	-0.9961
9	10.9963	9.9962	-0.9961
10	10.9969	9.9967	-0.9962

Pipette Calibration

Pipette calibration checks the accuracy and precision values of pipettes by weight analysis. An analytical balance is recommended for maximum accuracy. The balance is capable of recording data from 3 to 30 samples of each pipette tested. The density table for water is included and if liquid is used for pipette calibration, Voyager *Pro* will accept the alternate liquid's density in g/cc at current room temperature. Since all calculations are made within the balance, it is also required that you know the atmospheric pressure which has to be entered.

PIPETTE	Status	Fail
11/17/03 03:56:21	PI	Inaccuracy 1.52 %
Nominal 500.000L		Imprecision 0.32 %
495.6	25	
494.0	5	
492.4	8	
490.8	5	
489.2	25	

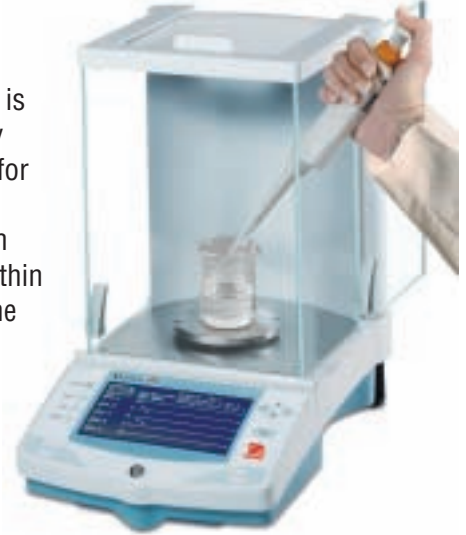

Density

Four methods of density determinations can be made with the Voyager *Pro* balance. These are:

1. Solids more dense than water,
2. Solids less dense than water,
3. Liquid density,
4. Porous material (impregnated with oil).

An accessory density determination kit is designed to be used with OHAUS Voyager *Pro* balances. A built-in reference density table for water at temperatures between 10°C and 30°C is included in the balance software. When making density measurements, the material should weigh at least 10.0 mg on an analytical balance and 100 mg on a precision balance.

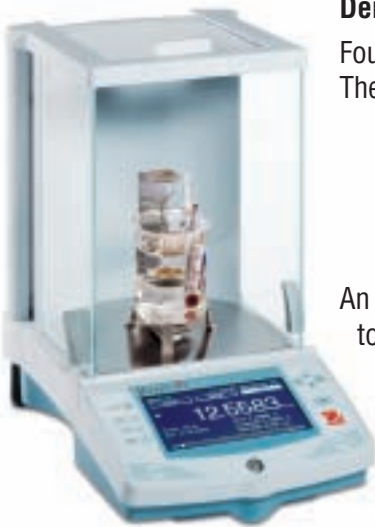

DENSITY	11/18/03 03:00:30 PM
TEMP	SETUP
12.5583 g/cc	
Temp: 25.0	Ref: 7.8500 g
Run: 0.9971	Liquid: 7.2433 g
	Volume: 0.63 cc

Formulation

Formulations can be named and have from 2 to 10 components specified. Once named, they may be recalled and used at any time. Each component of a given formulation can be specified as to its weight or percentage. Each element of a formulation

	Target	Result	Diff
ITEM 1	20.0000	19.9749	-0.0251
ITEM 2	37.0000	37.0485	0.0485
ITEM 3	48.0000	47.9860	-0.0140
Total	95.0000	95.0022	0.0022

is shown on a dual bar graph as a percentage and displays the desired weight. Thus, each component may be placed on the pan until 100% is indicated.

FORMULATION	01/23/01 21:09:14
RESULTS	SETUP
0.0000	
Item 1	Target: 20.0000 g
	Diff: -20.0000 g
	Pct: 0.0000 %
	305 305 100% 1100

Analytical and Precision Balances

The Voyager *Pro* features numerous application modes such as differential weighing and density determination and an applications library to store and quickly recall past procedures. An ultra-simple and innovative user interface allows for effortless set up and operation --essentially eliminating the need for any preliminary training. Additional standard features such as scroll down menus, on screen text prompts, high-resolution LCD display, five operating languages, and selectable environmental settings, make the Voyager *Pro* one of the most easy to use yet most accurate and advanced balance in its category. Other standard features include RS232 port for connectivity, GLP protocol, selectable auto-print settings, and an integral weigh below hook. To further protect your investment, Voyager *Pro* is designed with a spill channel and includes a display in-use cover. The Voyager *Pro* is manufactured to ISO 9001:2000 quality assurance specifications, for the traditional OHAUS quality you've come to expect

Key Features

Superior Draftshield

A large 3-door draftshield is standard on all Voyager *Pro* analytical and precision balances with a 0.1/1mg readability. The draftshield design provides optimum draft protection from wind currents for superior balance stability and reproducibility even in challenging environments. The large chamber can accommodate larger vessels and the removable side doors make it easy to clean.

Automatic Calibration

Voyager *Pro*'s standard AutoCal™ calibration feature automatically calibrates the balance when it senses a temperature change sufficient enough to affect weighing accuracy. This feature assures accuracy while saving operational time.

Protective Cover

Voyager *Pro*'s standard in-use cover is replaceable and protects the display from harsh environments or spills that can ruin the balance.

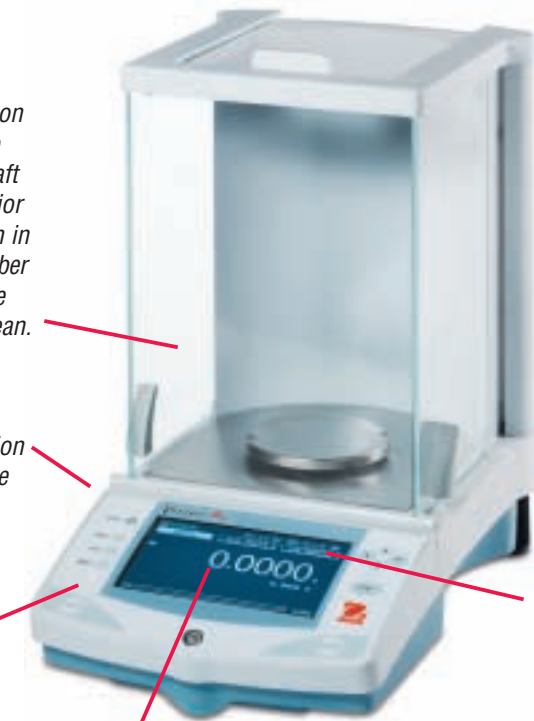

Large Brilliant Display

Voyager *Pro*'s high-resolution dot matrix display with backlight enhances viewing in any environment and has adjustable contrast and brightness controls. The display illustrates the weighing results with large numeric indicators and features user definable text fields to illustrate only the information you want! The display also illustrates secondary units, time and date.

Communications Port with GLP/GMP Data Output

The standard RS232 communication port offers connectivity and it's GLP/GMP data output capability prints time, date, balance, project, user ID, calibration information and weighing information. Simply connect your Voyager *Pro* to the optional OHAUS SF42 accessory printer and full traceability of weighing procedures is achieved without the need for sophisticated, expensive peripherals.

Innovative Software

Voyager *Pro*'s innovative user interface combines a dot matrix display with scroll down menus, software prompts and 5 operating languages. Balance setup and use is made simple and easy to follow with no training required. The three application-specific soft-keys allow direct access to features such as calibration, units, sample size and reference information at the touch of a button. An applications library stores and quickly recalls past procedures eliminating the need to re-establish application parameters.

With its advanced applications and innovative software, Voyager Pro is perfect for applications in pharmaceutical, research and quality assurance lab applications.

Voyager[®] Pro Electronic Balances

OHAUS Voyager Pro: Weighing Units for Every Application

For total versatility, Voyager Pro's offers 12 application modes and 16 standard weighing units* for almost any type of mass measurement application

Application Modes:	
• Differential Weighing	• Animal Weighing
• Formulation	• Parts Counting
• Statistics	• Percent Weighing
• Density Determination	• Check Weighing
• SQC	• Filling
• Pipette Calibration	• Gross/Net/Tare Weighing

- Milligrams
- Grams
- Kilograms
- Pounds
- Ounces
- Carats
- Troy Ounces
- Newtons
- Grains
- User Programmable Custom Unit
- Mommies
- Taels (3)
- Ticals
- Pennyweights

*Units availability is capacity/readability dependent

Feature	Advantage	Benefit
Advanced weighing applications standard • Pipette Calibration • SQC • Statistics • Formulation	Integration of applications into Voyager Pro as a complete solution	Provides simplified, automated measurement analysis saving time and cost on additional equipment.
AutoCal™ internal calibration standard on all models.	Voyager Pro models self-calibrate when they sense temperature changes.	Ensures accurate measurements in all conditions.
Intuitive keypad layout • Simple 2-button operation for basic weighing • Soft key dynamic mapping for advanced operation	Easy to use. Accessible and repeatable operation. Soft keys provide measurement flexibility.	No training required to operate balance. Saves time by allowing each mode to have dedicated keys.
Brilliant hi-resolution graphic display	High contrast and large size are easy to see and easy to read. Provides complete information. Enough space to hold pertinent measurement information.	Allows easy viewing in all lighting conditions; production lines, under vent hoods, etc. Less chance for human error and creates less strain on eyes. Eliminates uncertainty and potential for user errors. Display provides thorough measurement details, reduces amount of manual calculations.

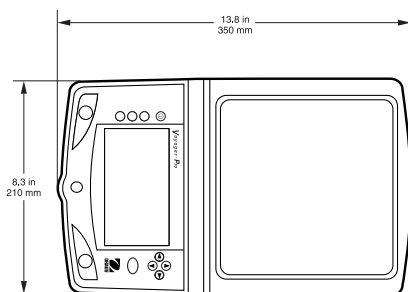

Voyager Pro Precision Balances

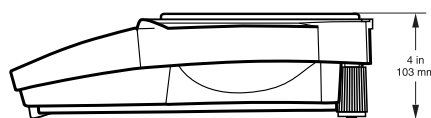

Voyager Pro Precision Models

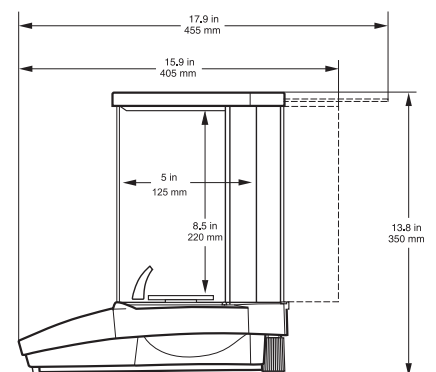

Voyager Pro Analytical Balances

Voyager® Pro Electronic Balances

General Specifications

Weighing Units	gram, milligram, ounce, ounce troy, carat, pennyweight, Hong Kong Tael, Singapore Tael, Taiwan Tael, mommes, grain, tical, Newton, custom
Application Modes	Statistics, Formulation, Differential Weighing, SQC, Density Determination, Pipette Calibration, Parts Counting, Animal Weighing, Check Weighing, Percent Weighing, Filling, Gross-Net-Tare Weighing
Features	Applications Library, RS232 Port, Auxiliary Display Port, GLP Protocol, Selectable Operating Language, Selectable Displayed Information Settings, Selectable Environmental Settings, Selectable Auto-Print Settings, Integral Weigh Below Hook, Contrast & Brightness Control, Protective In-Use Cover
Tare range	Full Capacity by Subtraction
Operating Temperature Range	50° to 104°F / 10° to 40°C
Power Requirements	100-120 V AC, 220-240 V AC, 50/60 Hz
Calibration	Internal / External
Display Type	LCD Dot Matrix w/Backlight
Display Size (in/cm)	240 x 128 pixels

Technical Specifications – Precision Balances

Model	VP213CN	VP413CN	VP613CN	VP413DCN*	VP612CN	VP2102CN	VP4102CN	VP6102CN	VP4102DCN*	VP4101CN	VP6101CN	VP8101CN	
Capacity (g)	210	410	610	100 / 410	610	2,100	4,100	6,100	1,000 / 4,100	4,100	6,100	8,100	
Readability (g)	0.001		0.001 / 0.01		0.01			0.01 / 0.1		0.1			
Repeatability (Std. dev.) (g)	0.0005		0.0015		0.0005 / 0.005		0.005		0.01		0.01 / 0.05		0.05
Linearity (g)	± 0.002		± 0.002 / 0.005		± 0.02			± 0.04		± 0.02 / 0.05		± 0.1	
Stabilization time (s)	3												
Pan size (in/cm)	4.7 / 12 dia.				6.8 x 6.8 / 17.2 x 17.2 w/windshield								
Dimensions WxHxD (in/cm)	8.3 x 13.8 x 13.8 / 21 x 35 x 35				8.5 x 4 x 13.8 / 21.5 x 10.3 x 35								
Net Weight (lb/kg)	13.2 / 6				11 / 5								

* Moveable FineRange™

Technical Specifications – Analytical Balances

Model	VP64CN	VP114CN	VP214CN	VP214DCN*
Capacity (g)	62	110	210	100 / 210
Readability (mg)	0.1		0.1 / 1	
Repeatability (Std. dev.) (mg)	0.1		0.1/0.5	
Linearity (mg)	± 0.2		± 0.2/0.5	
Stabilization time (s)	4			
Pan size (in/cm)	3.5 / 9			
Dimensions WxHxD (in/cm)	8.3 x 13.8 x 13.8 / 21 x 35 x 35			
Net Weight (lb/kg)	13.2 / 6			

* Moveable FineRange™

Accessories

	Ohaus Number
Dot Matrix Printer	80252042
Cable kit to connect Dot Matrix Printer to Voyager Pro	80500570
Paper for Dot Matrix Printer	80251932
Ink Ribbon for Dot Matrix Printer	80251933
Thermal Printer	80251992
Paper for Thermal Printer	80251931
Cable kit to connect Thermal Printer to Voyager Pro	80252580
Ohaus Collect Software	80500746
TAL Software WinWedge	SW12W
RS232 Cable, PC 9 Pin to Voyager Pro	AS017-09
RS232 Cable, PC 25 Pin to Voyager Pro	AS017-02
In-Use Cover for Voyager Pro	80850042
Security Device for Voyager Pro up to 8kg	470004-010
Density Determination Kit for Voyager Pro analytical balances (0.1mg)	80850045

C&M SCALE
CALL FOR A QUOTE!
www.cmscale.com

Toll Free (800) 243-3721
Phone # (708) 771-0100
Fax # (708) 771-0195

Industry Leading Quality and Support

All OHAUS Voyager® Pro balances are manufactured under an ISO 9001:2000 Registered Quality Management System. Our rugged construction and stringent quality control have been hallmarks of all OHAUS products for over a century.